



Waterstops

Standards

Couronnes jusqu'à 25 ml



SBR 60 Shore

Résistance Rupture

10 Mpa

Allongement

400 %

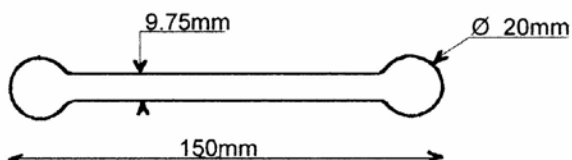

F.E. W 150 SBC

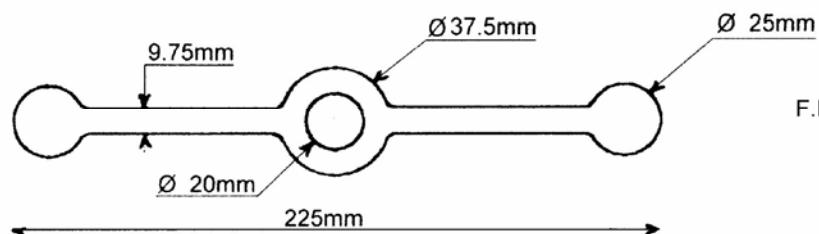

F.E. W 225 ABC

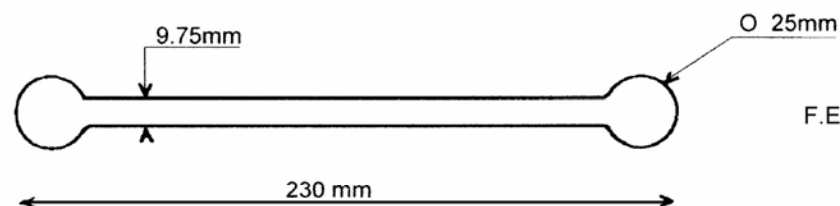

F.E. W 230 SBC

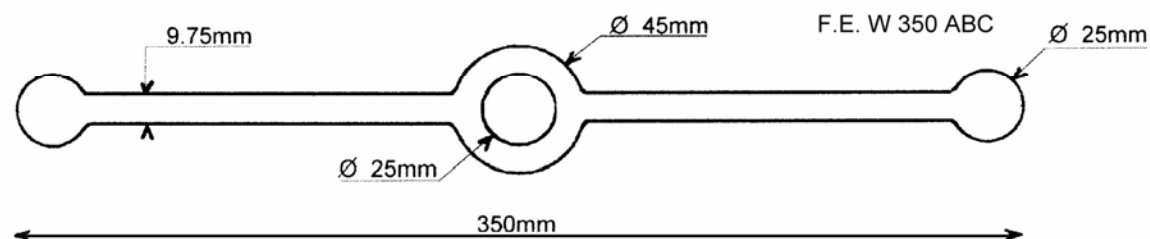

F.E. W 350 ABC

F.E. W 150 SBC	2.1 Kg
F.E. WA 150 ABC (6mm)	1.9 Kg
F.E. WA 225 (6mm)	2.7 Kg
F.E. W 225 ABC	3.7 Kg
F.E. WS 225 ABC	4 Kg
F.E. W 230 SBC	3.8 Kg
F.E. W 250 ABC	4.4 Kg
F.E. W 350 ABC	5.5 Kg

Flandre Elastomères

13, Rue Célestin Malo – 59210 Coudekerque-Branche

Tél/Fax : +(33) (0)3.28.26.95.54 - GSM : +(33) (0)6.28.32.03.80 – f.elastomeres@wanadoo.fr



Waterstops

Spéciaux - Allégés

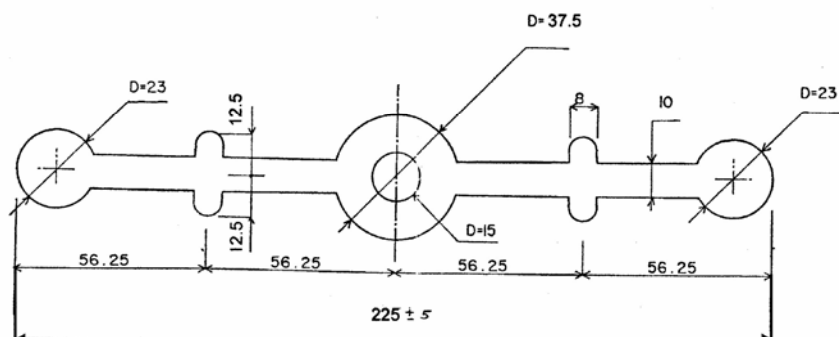

FE WS 225 ABC
Poids : 4 Kg
Couronne jusqu'à 25 ml

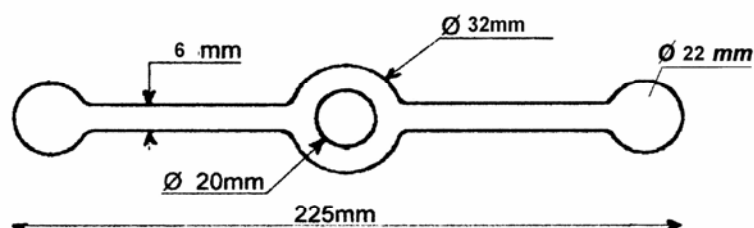

FE WA 225 ABC
Poids : 2.7 Kg
Couronne jusqu'à 25 ml

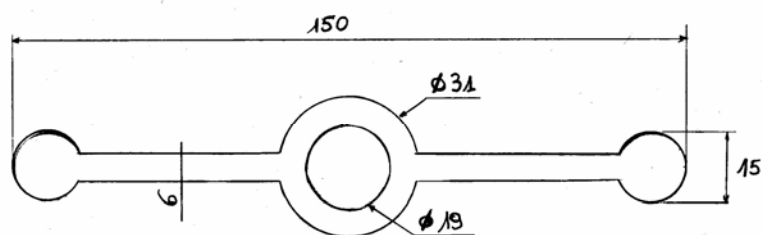

FE WA 150 ABC
Poids : 1.9 Kg
Couronne jusqu'à 25 ml

Dureté	60 Shore +/- 5
R. Rupt.	10 Mpa
All. R.	400 %
D.R.C. 70°	Inf à 25%
Densité	1.2